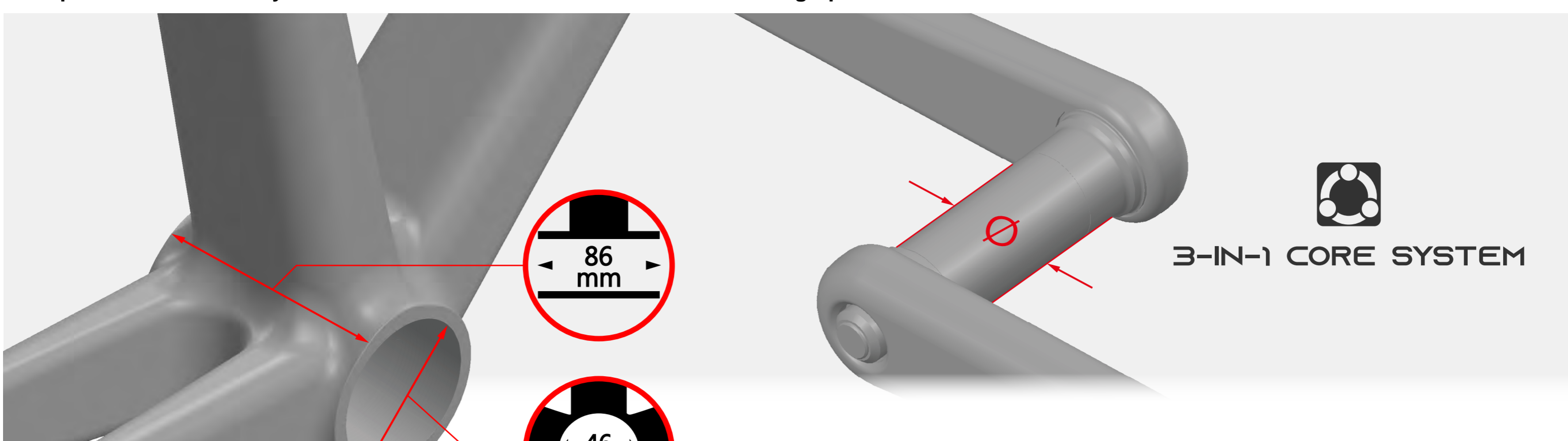

3-IN-1 CORE SYSTEM
Specification Check

- ◆ Before installation, please ensure that your bike frame and crankset meet the following specifications.

Bike Frame : BB386

 Twist-Fit Type
 Inner Diameter : 46mm
 Width : 86mm

Crank Spec: Shimano HT II : Ø24mm
SRAM DUB : Ø28.99mm
ROTOR 3D+ : Ø30mm
BB BB386 Anatomy

- ◆ Before installation, please ensure that the purchased BB meets the following specifications and includes the following contents.

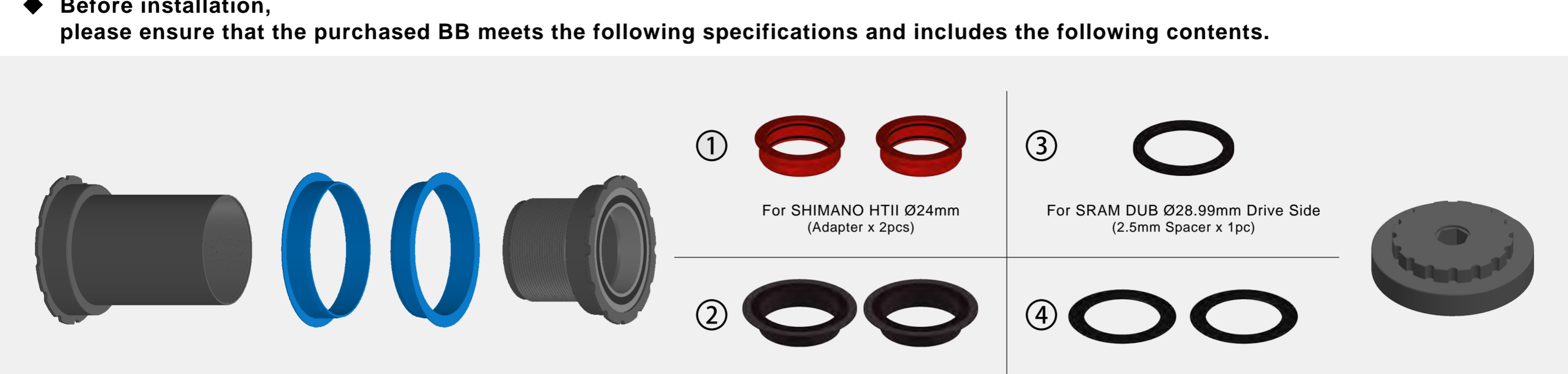
General Safety

- ◆ To install TRIPEAK Bottom Bracket, we strongly recommend that you have a trained bicycle mechanic at your local bike shop.
- ◆ Do not alter this product in any way as it can cause unseen damage. Any modifications to this product will void the warranty.
- ◆ Make sure the crankset is firmly attached to the bottom bracket, improperly attached cranks can become detached from the BB set.
- ◆ When cleaning the bottom bracket set, only use mild soap and water. Never use high-pressure water jet, it will cause BB cup internal water ingress and influencing the bearing rolling lifetime.
- ◆ If you have any questions or concerns about this product, Please feel free to contact us. E-mail: info@tripeakbearing.com

Required Tools

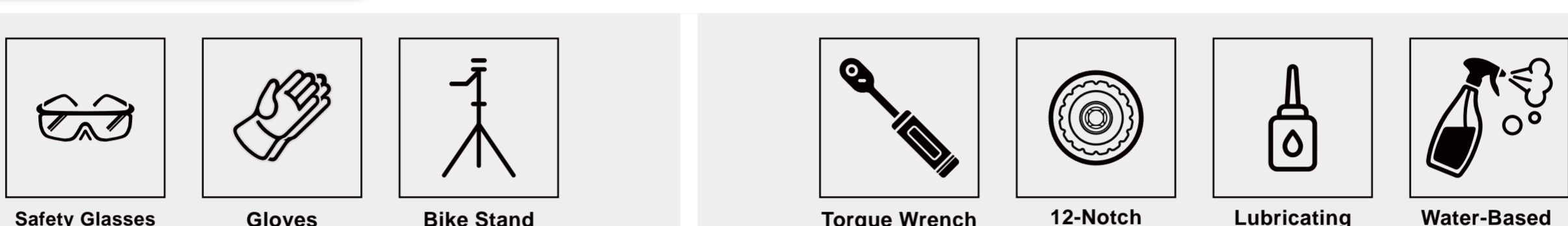
 TRIPEAK Tool Required : B015
 Tool compatible with torque wrench for installation use.

Bottom Bracket Installation

Ensure that the internal cable routing of the frame will not interfere with the bottom bracket (BB) installation. Clean the inside of the BB shell on the frame, ensuring it is smooth and free of debris. Apply a thin layer of grease to the inner edges of the BB shell to assist with smooth BB installation.

Remove the drive-side BB, which will be installed later.

Gently position the non-drive side BB along with the non-drive side Snug Ring into the non-drive side of the BB shell. Using a dedicated BB installation tool, press the non-drive side BB into the BB shell of the frame until there is no gap between the BB and the frame.

During pressing, ensure the BB is inserted at a proper vertical angle to the frame. If you encounter excessive resistance while pressing, stop the process and recheck the insertion angle and the BB shell for any debris or deformation.

Remove the Snug Ring from the drive-side BB and first press it into the drive-side of the frame's BB shell. Align the drive-side BB vertically with the inside of the drive-side BB shell on the frame, and rotate it counterclockwise to insert. Then, use the BB wrench (B015) to fit the drive-side BB shell, continuing to rotate counterclockwise to press it in. Tighten to a torque value of 30Nm, ensuring there is no gap between the BB and the frame's BB shell, completing the BB installation.

If the non-drive side BB rotates along with the drive-side BB during installation, prepare another BB wrench (B015) to secure the non-drive side BB in place, ensuring the required torque value is reached.

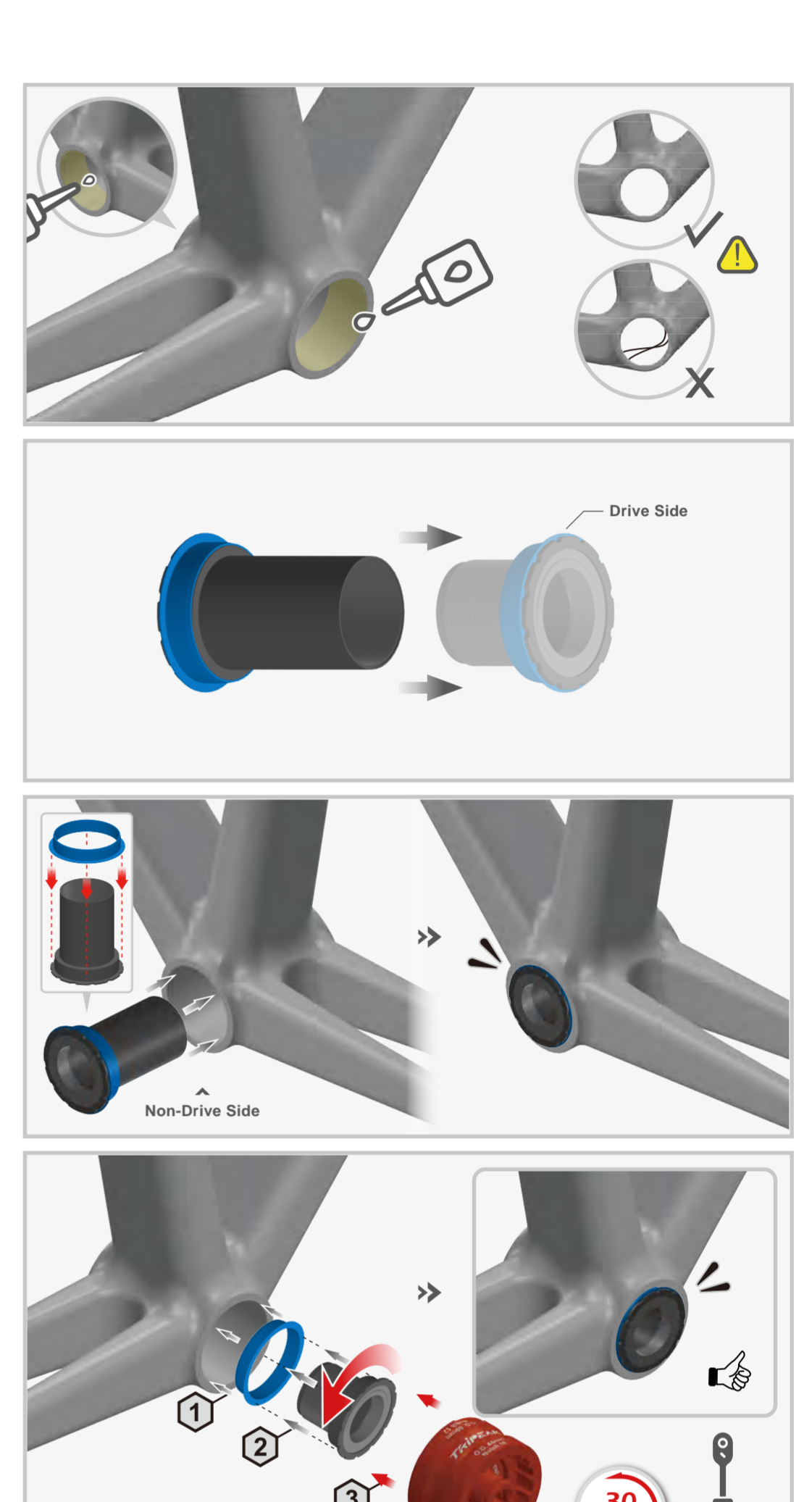
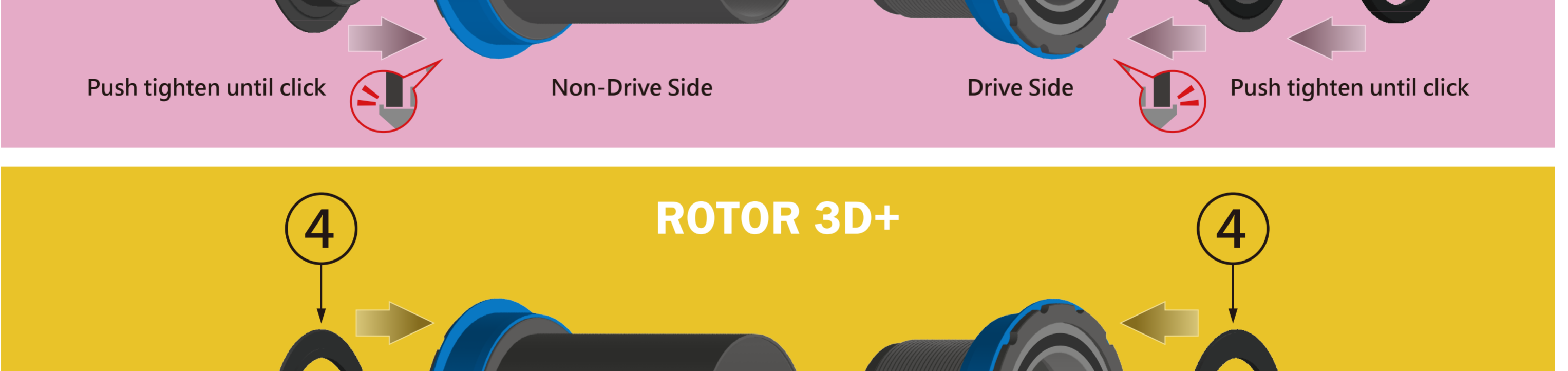
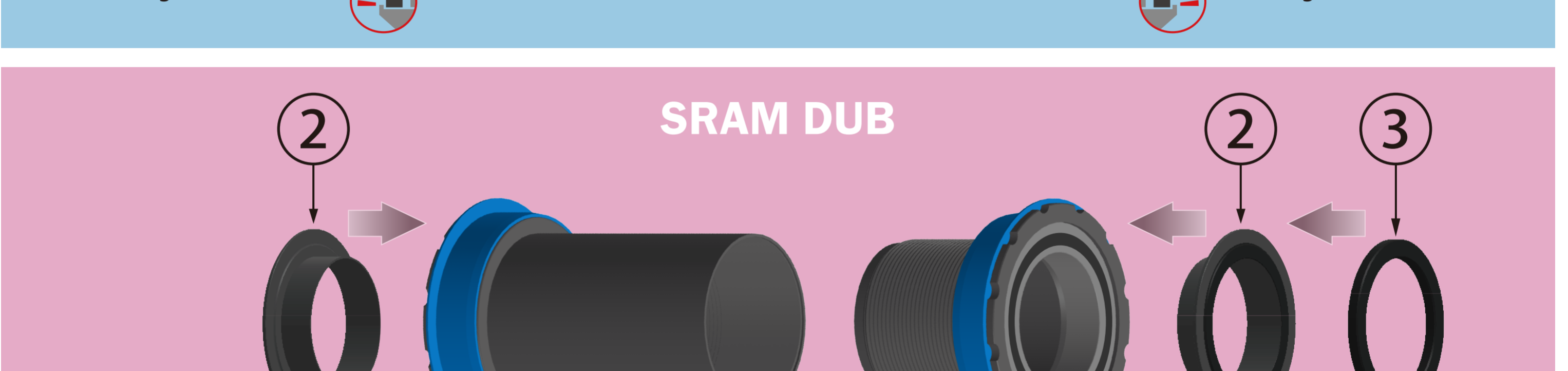
Installation of Crank's Adapter
3-IN-1 CORE SYSTEM

Bottom Bracket Maintenance

- ◆ For maintaining and servicing TRIPEAK bottom brackets, we strongly recommend hiring a trained bicycle mechanic at your local bike shop.
- ◆ Regular maintenance is generally recommended after riding 5,000-10,000 km. If riding in harsh conditions (wet, dusty, extreme temperatures, etc.), it is advised to perform maintenance immediately after riding.
- ◆ Avoid repeated disassembly and reassembly of the BB Cup unless necessary, as maintenance should only focus on the BB bearings to prevent damage to the frame.
- ◆ Do not use high-pressure water jets to clean the BB to avoid water infiltration and bearing damage.
- ◆ Regularly check the torque value of the BB Cup, and do not ride with a loose BB Cup.
- ◆ Bearing specifications for BB386 BB. (OD x ID x H mm)
 | Drive Side : 42 x 30 x 7mm (6806-2RS) | Non-Drive Side : 42 x 30 x 7mm (6806-2RS)

Reapply lubricant to Bottom Bracket

Carefully use a small tool to gently pry off the out outer seals from the bearings. Use a suitable solvent to clean the bearings thoroughly, removing old lubricant and any debris. Allow them to dry completely.

Be cautious not to damage the seals or the bearings.

Use TRIPEAK ETERNA LV Fluid or the appropriate lubricant to Add a full lap of bearings. Be sure to use the correct type of lubricant recommended for your specific bearings.

Rotate the bearings gently by hand to ensure the lubricant is evenly distributed.

Carefully press the seals back into place on the bearings, ensuring they are seated properly and securely.

After reassembly, check to ensure the bearings move smoothly and without resistance.

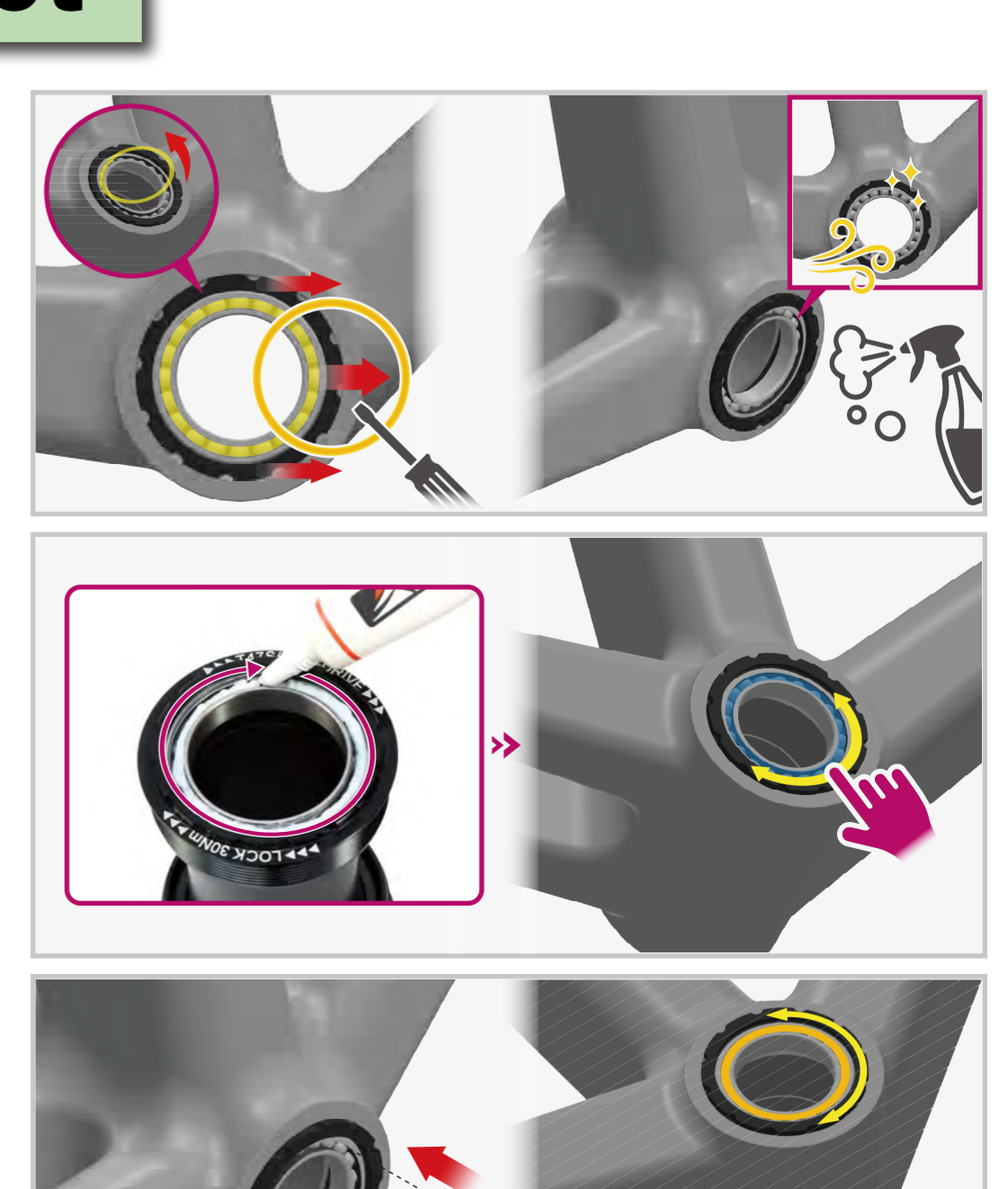
3-IN-1 CORE SYSTEM